

mariz



Installation, Care & Maintenance

CARYSIL

About your mariz worktops

These worktops were developed to make compact laminate an easy-fit option without the need for specialist templating or tooling. By following these instructions, we know that competent installers can achieve excellent results.

Handling and storage

When handling this product, always lift with at least two people. Carry the worktops upright on its edge to prevent damage.



mariz worktops should be stored horizontally on a flat, dry, well-ventilated area away from heat sources and dampness. Never store upright, vertically, or directly on the floor as this may cause bowing and distortion. If you have more than one worksurface, ensure that cardboard is used between boards to protect the surfaces from damage.

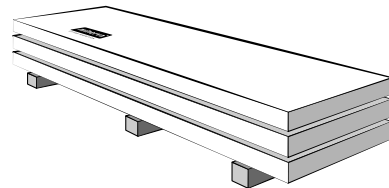

Tools & Consumables required:

General Tools

- Circular Saw with track

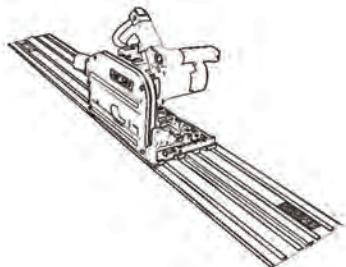

- TCT triple chip circular saw blade



- Straight edge – at least 2 metres



- Hand router: minimum of 1850W with ½" collet

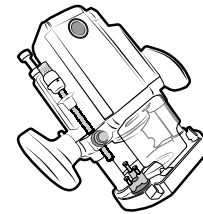

- 30mm Guide Bush



- 12mm TCT Router Cutter with 30mm guide bush



- Straight trim router cutter (with guide bearing)



- Biscuit Router Cutter (size 20)



- Jig saw – with metal cutting blade



- Orbital Sander



- G Clamps



- Masons Mitre Jig

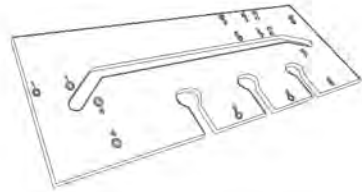

- Masking Tape

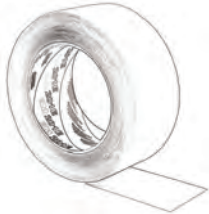

Installation kit



- Drill



- Silicone Gun

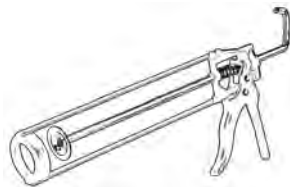

This kit is supplied with:

- 2 isopropyl alcohol wipes
- Sandpapers in the following grades: P120, P240, P320
- Grey abrasive pad
- Sanding block
- 3 jointing biscuits (No.20)
- Hexagonal wrench
- Linseed oil
- 3 compact worktop connector bolts

Before you begin

- Any claims after installation relating to inconsistency will not be covered by the product warranty.
- Ensure that the worktop has acclimatised for at least 24 hours to room temperature prior to fitting.
- Make sure to check all cabinets are level and firmly secure prior to installation. Cabinets should be levelled within a tolerance of 3mm for every run of 3m cabinetry.
- Dust particles will be generated when cutting, routing, sanding, and drilling the worktops – ensure protective eyewear and a P3 dust mask is worn during these tasks.
- Ensure the area you are working in is well-ventilated and an appropriate dust extraction system is used.

- Joints should be at least 100mm away from all cut-outs.
- Ensure all cutouts are at least 50mm from the front edge of worktop.
- Do not join through a cutout or where a cutout is intended.
- Allow an expansion clearance between worktop and wall of 1mm for every linear meter of the worksurface.
- Allow for at least 50mm of clearance behind hobs. Gas hobs may require additional clearance. Always adhere to your hob manufacturers guidelines regarding ventilation and clearances.
- Provide additional support where necessary, such as for hob or sink cut-outs that require the removal of part of the cabinet rail.
- All joints must always be supported by either wall battens or cabinetry. Additional battens and metalwork are needed where joints do not fall on the carcass.

Planning your layout

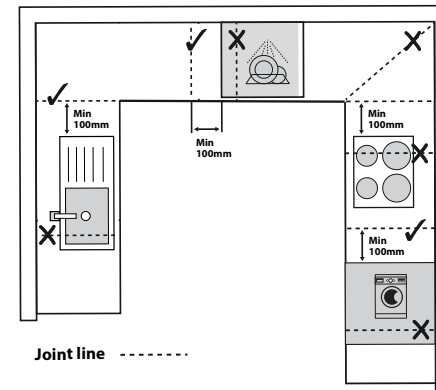

Breakfast bars

When using **mariz** as part of a breakfast bar, overhangs of up to 300mm are permitted, but support is recommended every 600mm along the length. Where wider units are used, support should be provided where possible. Unsupported spans over 1000mm are not recommended.



- In the case of a handle-less kitchen, refer to the cabinet manufacturer's instructions regarding support and any additional battening requirements.

Unsupported overhangs are permitted, but the following parameters should be adhered to:

- The supported area must be a minimum of 3 times the overhang.
- The total overhang to all sides must not exceed 1/3 of the supported area.

Fixing

Do not screw directly into this product! To secure the worktops to the base units, apply a 4-6mm bead of low modulus silicone sealant along the full run of units.

As an approximate guide, 50% of the top edges of the cabinets should be beaded with silicone. More coverage may be required when adhering breakfast bar tops as they typically require a strong adhesion.

Cutting to size

mariz worktops are hardwearing, they require good quality tools and sharp cutters to achieve a quality finish.

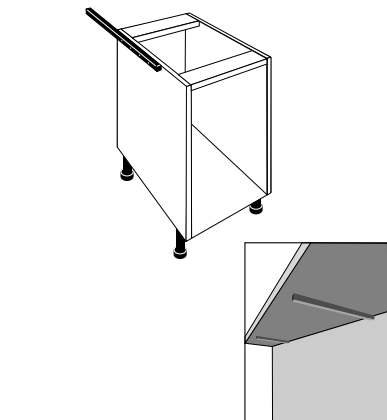

- Support to the overhang can be achieved using L brackets, metal support bars screwed into the cabinets, or breakfast bar legs.

- Use non-residue masking tape to mask the desired cut area before marking the cutline on top of the tape. Do not mark directly onto the worktop surface!
- Check measurements repeatedly to avoid errors.
- Eye protection and dust mask must be worn when cutting routing and sanding.

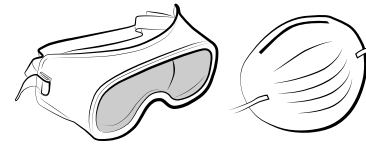

- Use a hand-held circular or plunge saw with a triple chip TCT blade and a straight edge/track for guidance.
- Due to the hardness of **mariz**, we recommend that the material is cut in 3 to 4 passes, lowering the blade by 3-4mm each pass.
- Ensure to overcut the material by 2-3mm, this excess will be trimmed by router to the finished size on the following steps,
- Slow or soft start tools must achieve full speed before beginning the cut.
- Ensure that the worktop is adequately supported when cutting.

- Use appropriate clamps to prevent movement of the guide/jig during cutting.
- All cut edges should be skimmed to the finished size using a router. Ensure a clean, sharp, double fluted TCT straight cutter is used.
- Inspect the quality of the fit and repeat the trimming process if necessary.
- Finally, use the grey abrasive pad to polish the edge, dampen the pad before use.

Edge Finishing

Standard **mariz** worktops come ready-finished on the front and return edges, while breakfast bars are finished on all four edges, eliminating the need for additional polishing or oiling.

However, if a cut edge needs to match the manufactured edge, the following steps are necessary.

Warning!

Sanding and finishing should only be done on the edge of the worktop. The face of the worktop must not be sanded.

- Utilizing an orbital sander or a sanding block, use the P120 sandpaper to sand the edge of the worktop.



- Gently sand in a constant linear motion along the worktop edge. Avoid an up and down motion as this can cause unwanted grooves.
- Ensure the sander remains flat to the edge '90 degrees to the surface' and avoid tipping, as this may result in uneven sanding and rounding.
- Continue to use the P120 paper until all cutting marks are removed.
- Clean the edge with a damp cloth between each pass to eliminate surface contamination and check quality.
- Repeat the same sanding technique with the 240-grit, followed by the 320-grit sandpaper.
- Once finished, dry the edge and apply linseed oil to the exposed edges, use a cloth to remove excess oil and buff. This not only seals the worktop against moisture and humidity but also provides a smooth and aesthetically pleasing finish.

Inset Hobs and Sinks

Always follow the provided instructions from the hob or sink supplier. Ensure that any install has adequate clearance between surface and appliance. Direct heat contact can result in damage. Heat reflective tape is supplied with the surface and **MUST** be used, along with any hob gaskets provided with the hob.

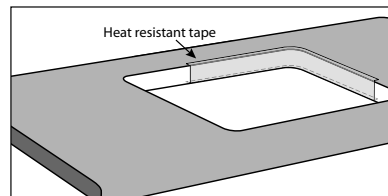

TOP TIP 1

When cutting a hob or sink cutout, we would recommend that the mariz worksurface is placed on a solid substrate whilst machining. This will ensure that the cut out does not drop and cause damage or injury.

TOP TIP 2

If making a cutout, it can sometimes be beneficial to fabricate your own jig from MDF.

- Start the cut-out process by drilling a 10mm+ diameter hole in each corner for square cut-outs. Always drill into a spare piece of MDF or chipboard to prevent chipping.

- Cutouts must have a corner radius of 5mm or greater. Radii smaller than 5mm are not permissible.
- Employ either a router with a 12mm cutter, or a Circular Saw. For both methods, plunge down and cut in 3-4 passes, joining the previously drilled holes.
- For cut-outs with curves or a large corner radius, it is recommended to use a jig and router.
- Use the P120 grit sandpaper and sanding block to smooth the inner edge of the cutout.
- Clean the edge with a damp cloth.
- Refer to the sink manufacturer's guide for bonding and fixing.

Undermount Sinks

- A router and jig must be used for all undermount cutouts.
- Ensure that the jig is accurately placed in the desired position onto the worktop face.
- Use clamps to secure the jig in position.
- Using a 12mm TCT router cutter with 30mm guide bush, machine the cutout in 3 to 4 passes, increasing the depth of cut by 3-4mm each pass.

- Use the P120 grit sandpaper and sanding block to smooth the inner edge of the cutout.
- Sand the internal radius by hand to ensure the profile remains smooth.
- Clean the edge with a damp cloth between each pass and check quality.
- Repeat the same sanding technique with the 240-grit paper, followed by the 320-grit paper, and finally the grey pad.
- Wipe away all dust and debris with a cloth, before applying linseed oil to the exposed edge. Use a cloth to remove excess oil and buff.
- Dry fit the sink to check the position before sealing.
- Always refer to the bowl manufacturers installation guide for fixing.

Joining mariz worktops

mariz worktops come with slightly softened factory-finished edges. To ensure a high-quality, discreet finish when jointing, all factory-finished edges must be cut then skimmed with a router.

Joining lengths

A simple butt joint is sufficient for joining two lengths together.

Butt joint for joining lengths

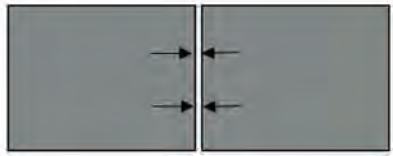

- Determine the join location, adding 2-3mm extra to the length. The extra material will be trimmed back later to achieve a clean finish. Follow the previous sections instructions about "cutting to size" to make the initial cut.
- Skim the Edge: Use a jig or straight edge to make a 90-degree cut. Ensure the jig is correctly offset to achieve the desired finished size and firmly fix it in place with clamps. Using a router cutter carefully skim the edge in one full depth cut. Use a sharp cutter to avoid chipping.
- Test the fit to ensure the joint is satisfactory, then proceed to the "joint assembly" section.

Corner jointing

For corner and L-shape joining, a masons mitre is recommended.

- Use a mason's mitre jig to achieve the correct jointing profile. Follow the jig manufacturer's instructions to ensure correct positioning and handing.

Ensure the jig is fastened securely in place with G-clamps.

- Use a router with 12mm TCT cutter and a 30mm guide bush. Cut in three to four passes, lowering the cutter by 3-4mm each pass.

Mason's mitre for corner jointing.

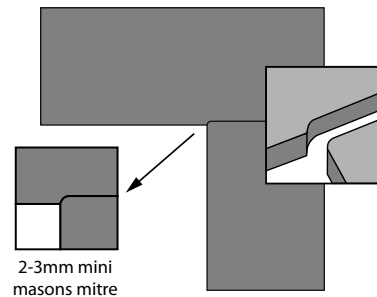

- Test the fit to ensure the joint is satisfactory.

Joint assembly

For a robust and durable joint, all joints must be reinforced with biscuits and compact worktop connector bolts.

- Apply masking tape to the underside edge of both pieces for marking out.
- Mark out the position of three biscuit slots and three compact bolt slots. These should be spaced equally across the join, alternating biscuit, bolt, biscuit, etc., and mirrored on both pieces.

Slimline toggle bolt installation

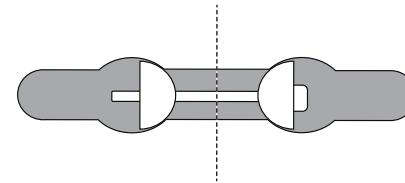

Straight butt joint

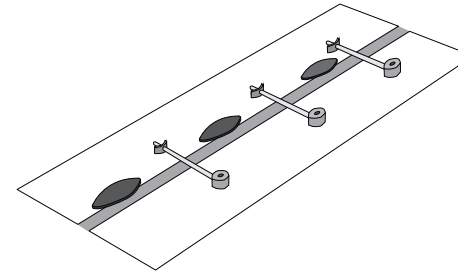

- Use a jig with the correct size pocket profile for compact worktop connectors. Always refer to the jig manufacturer's guide before proceeding.

Position the jig and securely clamp it in place. Using a router with a 12mm TCT cutter and the relevant guide bush (depending on jig requirements), cut the pocket to a depth of 7mm.

We recommend making the cut in two passes. Repeat for all sections requiring a connector bolt.

- Use a biscuit cutter or router (fitted with a biscuit blade) to cut slots in the edge of the worktop to receive a size 20 biscuit. The slot should be 4mm wide and positioned 4mm from the top edge.
- Dry fit to ensure correct alignment.
- Before applying the adhesive, clean the edges and grooves with an alcohol wipe provided in the installation kit.
- Apply the adhesive to the biscuit grooves and push the biscuits into position. Apply an even bead of adhesive to the entire edge to be joined and bring the worktops together.
- Tighten and secure the toggle bolts using the hex key provided in the installation kit.
- Clean the surfaces with an alcohol wipe to remove any remaining adhesive on the surface.
- Leave the jointed work surfaces for 15 hours to allow the adhesive to fully cure.

Freestanding Cookers

- Ensure that the level of the hob does not sit below the worktop as this can cause direct transfer of heat or flame towards the surface.

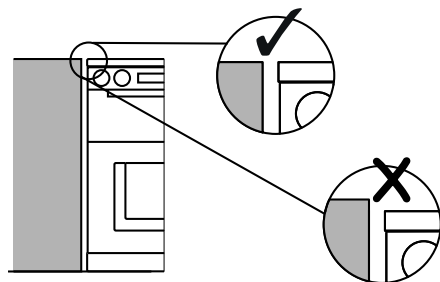

- The edges of the appliance should not be in direct contact with the work surface. In normal circumstances, a gap is required around the appliance to enable removal for service.
- If the installation incorporates an Aga or other heat-generating appliance, we recommend a minimum of 50mm clearance needs to be allowed from the edge of the cooker to the work surface.

Care and Maintenance

mariz worksurfaces are non-porous and resistant to stains, mould, mildew, and bacteria growth. Because of this **mariz** can be easily maintained with clean warm soapy water and a damp cloth. This will remove everyday dirt, grease, and spills. Make sure to dry the work surface with a clean, dry cloth to help prevent water stains.

Stain Removal

- For common stains such as coffee, tea, or food spills, gently scrub the affected area with a soft cloth or sponge and a mixture of warm water and mild dish soap. Rinse thoroughly and dry.
- For tougher stains such as wine a non-abrasive cream cleaner and non-abrasive brush can be used, rinse with warm soapy water afterwards and dry with a clean cloth.

Preventative maintenance

- Use a chopping/cutting board when preparing food to prevent scratches.
- Never place hot items directly onto the work surface as this can cause heat damage to the laminate. To prevent this, use heat pads when placing hot items down.
- Avoid using harsh chemicals such as bleach or abrasive cleaner on the surface as they can cause damage and discolouration.

WARRANTY REGISTRATION FORM **mariz**

Name

Address.....

..... Post Code

Tel

Email

Where did you purchase the work surface?.....

Works order number

Date of purchase

To be completed by installer

I certify that this **mariz** work surface has been fitted in accordance with the prescribed installation instructions

Signed.....

Date

Please print name (FITTER)

Please return to: Carysil Surfaces Ltd, Azalea Close,
Clover Nook Industrial Park, Alfreton, Derbyshire DE55 4QX
Tel: 01773 521300 E-mail: info@carysil.co.uk

Or register warranty online at www.marizwarranty.co.uk

Data Protection: Carysil Surfaces Limited may use your information for administration, customer analysis, customer service and targeted marketing. We may contact you by email, SMS, telephone, fax or other reasonable methods to let you know about other products, services or promotions that may be of interest to you. If you do not want to receive such information and offers the please tick.

WARRANTY

Your worktops have a 10 year warranty against manufacturing defects. The additional 9 year warranty (1 year is statutory) should be registered no later than 90 days from the date of installation to validate any claims.

In order to validate this warranty, the form on page 13 must be completed by the consumer, signed by the fitter and returned to Carysil Surfaces Limited.

You can also register your warranty online at www.marizwarranty.co.uk.

It is imperative that the installation and care and maintenance instructions are referred to both before and after installation, as misuse of the worksurface may affect the appearance of the product. This does not affect your statutory rights as a consumer.

The warranty applies to the first owner and first installation only and is not transferable.



mariz

CARYSIL

Carysil Surfaces Azalea Close Clover Nook Industrial Park
Alfreton Derbyshire DE55 4QX

t 01773 521 300 e surfacesales@carysil.co.uk www.marizworksurfaces.co.uk