

metzo

Installation, Care and Maintenance Manual Warranty Registration Document



NB THIS LEAFLET MUST BE LEFT WITH THE CONSUMER AFTER INSTALLATION;
GUARANTEE AND IMPORTANT MAINTENANCE INFORMATION ENCLOSED.



About your metzo worktops

These worktops were developed to make solid surface an easy fit option without the need for specialist templating or tooling. By following these instructions we know that competent installers can achieve excellent results.

Preparation

- The work surfaces and additional materials must be conditioned for at least 24 hours at room temperature prior to fitting.
- Work surfaces should be stored horizontal and flat in a dry, well-ventilated area.

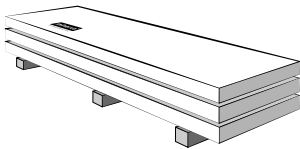

Must not be stored vertical and on one edge

- **It is essential that the cabinets are checked to be level prior to fitting the worktops and checked again following installation of the worktops. The cabinets should be levelled to a tolerance of no more than 3mm for every run of 3m cabinetry. Use of a laser alignment device is recommended however a level can be achieved in other ways.**

After the worktops are in position, please ensure the cabinet legs are firmly on the floor so no movement can occur.

- The worksurfaces are supplied with a final matt finish and do not require any further surface finishing apart from areas that require joints and any cut ends or edges.
- All surfaces should be checked for any damage and colour consistency prior to

installation. If you are unsure of the colour consistency, sand a small patch of each of the adjoining boards to test this to ensure a satisfactory match before any installation is carried out. Ensure you are in a suitably lit environment, wipe the dust away and use a damp cloth to help get a true colour comparison.

Any claims after installation relating to inconsistency are not covered by the product warranty.

- Darker colours show scratches and marks more easily and should be treated with extra care and attention during and after installation.
- Dust particles will be generated during the cutting, routing, sanding and drilling of the worktops. As a result of this, it is important to ensure the area you are working in is well ventilated and an appropriate dust extraction system is used. metzo solid surface is completely non-toxic, however the adhesive used for joints contains methyl methacrylate and ventilation should be considered to ensure fumes are dissipated.
- To secure the worktop to the base unit apply a 4-6mm bead of low modulus silicone sealant along the full run of units. As an approximate guide, 50% of the top edges of the cabinets should be beaded with silicone. Due to the weight of the work top, this is sufficient to hold it in place.

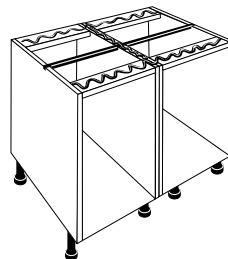

Installation Guide

Tooling required

- Spirit Level or Laser Alignment Device.
- 2½ HP, 1850 watt router

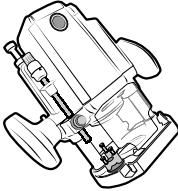

- Mason mitre jig with 30mm guide ring and 12mm twin flute tungsten carbide tipped cutter.

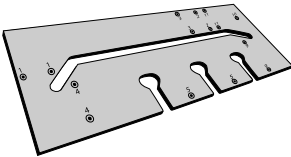

- Random orbital sander for finishing.

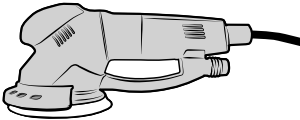

- Hot Melt Glue gun, glue, clamps or Seaming Tools.

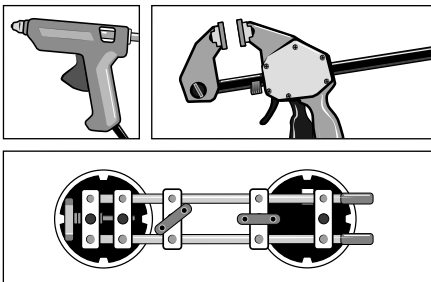

- Also required:
Jointing kit - 1 kit per joint.

This kit is supplied with 2 part acrylic adhesive (10:1 adhesive and activator), 2 isopropyl alcohol wipes, 6 MDF Jointing Blocks and sandpapers in the following grades: P120, P240, P320 grit and grey abrasive pad.

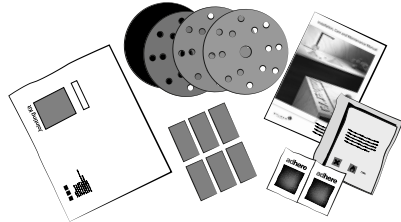

- ***We do not recommend the use of any finishing products to enhance the appearance of these worktops other than those supplied in the Care Kit. The surface is factory finished to a matt finish and we do not recommend that a higher gloss level is attempted.***
- ***Only use the sanding grades recommended in this installation guide.***

Planning your layout

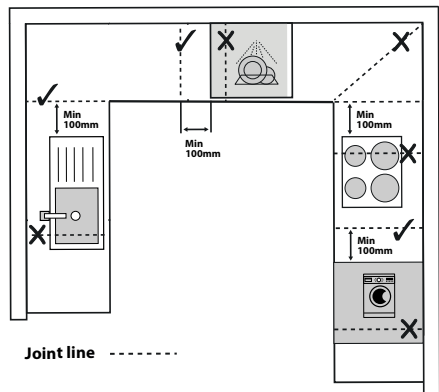

- If the appliance allows, cross supports should be added. Bracket to wall to centre of gap.

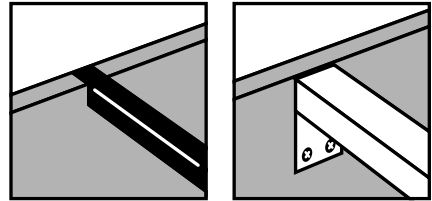
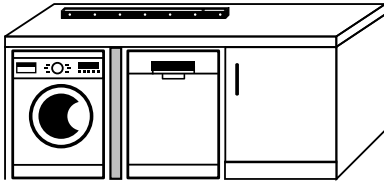

- All joints must always be supported by either wall battens or cabinetry. Additional battens and metalwork are needed where support is required.
- We recommend a mini masons mitre joint is used. This ensures that the faces being joined are clean cut and the factory profiled edges are removed. All edges for jointing must be cut.

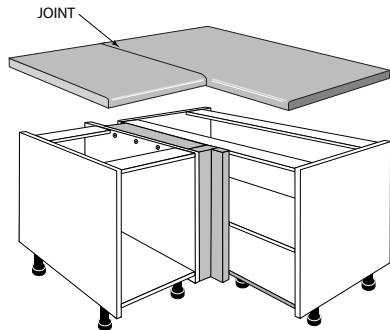
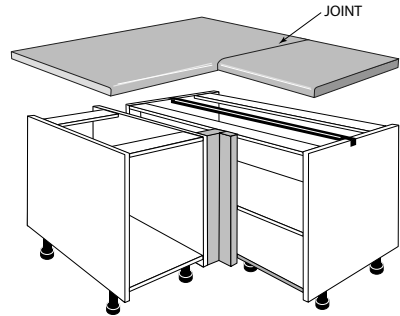
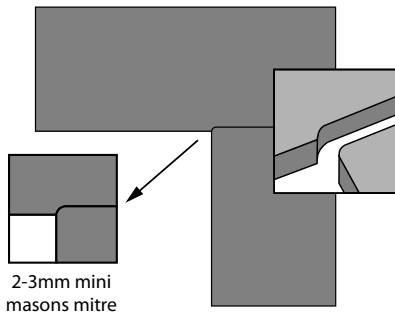

- No joints should be made above a dish washer, washing machine, washer dryer or in the area around cut-outs.
- Joints should be at least 100mm away from all cut-outs and dishwasher installations.
- Where a cabinet cannot offer adequate support, additional bracing must be added to the cabinet to ensure full support of the metzo joint at the front and the back. All joints should be supported across at least 3 points. We recommend a timber batten of at least 50mm x 50mm (2" x 2") or a metal bar but site conditions may vary.

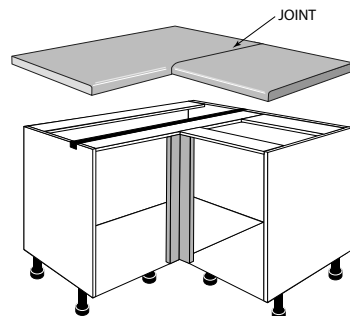

Installation Guide

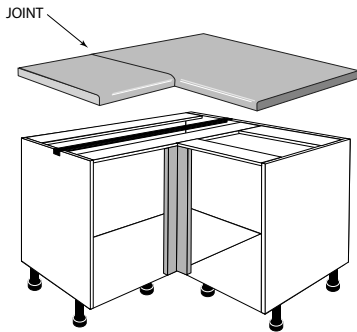

- Additional support may also be necessary where the cut out for a hob or sink requires the removal of part of the cabinet rail. In this situation the addition of a metal rail is required in order to prevent sagging or a potential weakness. E.g. B&Q Steel Square tube (H)20mm (W)20mm (L)1m.
- Always refer to the manufacturer's instructions to ensure that rules regarding ventilation are adhered to.
- If the installation of the hob requires removal of the front rail, replacement support will be required.
- When using metzo as part of a breakfast bar configuration, we advise that an overhang of up to 300mm is permitted, but support is recommended every 600mm along the length. Where wider units are used, support to be provided where possible. Unsupported spans of over 1000mm are to be avoided.

Example 1.

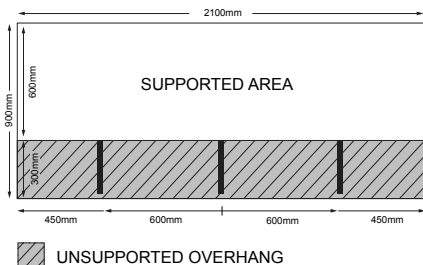

Example 2.

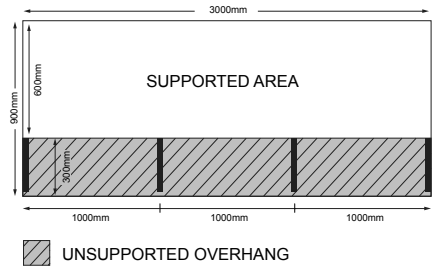

- In the circumstance where support bars/ brackets are not feasible, an unsupported overhang of up to 200mm is permissible, provided the supported area is a minimum of 3 times the overhang and the total overhang to all sides is no more than 1/3 of the supported area. E.G 200mm overhang where cabinet support is 600mm
- Support to the overhang can be achieved using L shape brackets, metal support bars screwed to the cabinets, or breakfast bar legs.

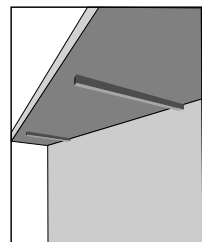
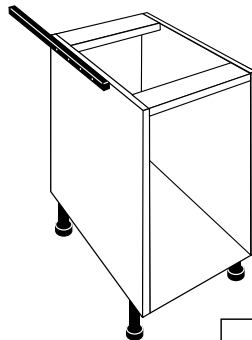

- In the case of a handleless kitchen, refer to any relevant manufacturer's instructions regarding supports & any additional battening required.
- Ensure all base units are level & securely fix into place. All legs to be in contact with the floor which should be checked both before and after the installation.
- If any additional fixings are needed in the worksurface, you will need to drill a hole, and then use adhesive to secure a brass insert into the hole. You can then screw into the insert - Do not screw directly into the surface as this can cause the surface to split. We recommend an M6 regular length threaded insert, max length 10mm.

Packs of 8 available on our website.
www.minervaworksurfaces.co.uk



- Use of a Boiling Water tap is not recommended with acrylic bowls.
- Avoid pouring boiling water into empty acrylic bowls as this can lead to superficial crazing of the surface. Running cold water at the same time will help to prevent this.

Slow Cookers

- As all slow cookers may operate at varying temperatures, we would always advise use of a trivet, chopping board, heat mat etc. to protect the surface from any damage.
- In all cases a gap is required to ensure air flow e.g. in the case of a chopping board, this should have feet so it sits slightly above the surface

Freestanding cookers

- Ensure that the level of the hob does not sit below the worktop as this can cause direct transfer of heat or flame towards the acrylic surface.
- The edges of the appliance should not be in direct contact with the worksurface. In normal circumstances a gap is required around the appliance to enable removal for service. This gap will allow sufficient clearance from the worksurface.

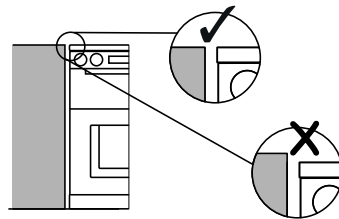

- If the installation incorporates an Aga or other heat storage range, we would recommend a minimum of 60mm clearance needs to be allowed from the edge of the cooker to the worksurface.

Hobs

- Ensure that any installed hob has adequate clearance from the surface, use the heat reflective tape supplied with the surface and the hob gasket where supplied, must be fitted. Direct heat contact can result in damage.

Cutting the worksurface

- Eye protection and a dust mask should be worn when cutting.



Installation Guide

- Tops may be over-cut, with a saw, by a minimum of 5mm and trimmed back using a router with a 12mm cutter and the straight edge of a jig.
- Always ensure that both sets of the cut are adequately supported. When cutting from the underside of the material, use a soft pad to avoid scratching. If you are cutting using a hand held skill/circular saw then cut face up. Cut edge should always be clean cut with the router.
- **Please note** that an expansion gap of 1mm per metre of worksurface is required when fitting the product between two walls.

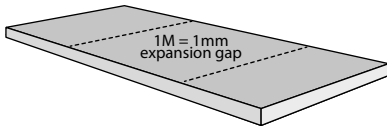

Jointing the worksurface

1. Use a router and 12mm cutter with a straight edge to cut the female worksurface to the desired length.
2. To prepare the cut faces for jointing, each side of the joint needs to be square cut. The broken/profiled edge of the surface edge needs to be removed and a small matching radius sanded on the 'dog-leg' of the male side of the joint to ensure seamless effect is achieved.

To ensure the best fit of these faces, one should be cut face up and the other cut face down.

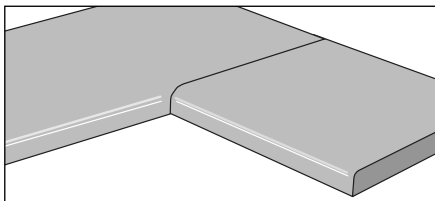

3. Using the isopropyl alcohol wipe supplied in the jointing kit, clean the cut edges of the worksurface. Ensure all surfaces are clean, dry and free of debris and dirt including the surrounding areas before proceeding to the next stage

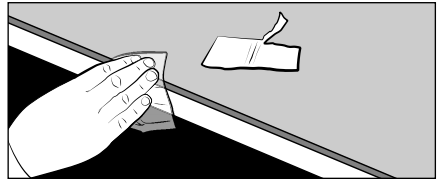

4. Position two layers of masking tape approx 3mm from the edge of each joint line.

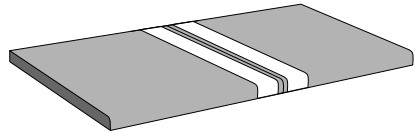

5. It is essential that the joint is dry fitted before bonding, to check it has been machined correctly. The joint surfaces may require block sanding to ensure the cut edge is true. This will ensure that the two machined edges will draw together flush.
6. If not using the Optional Joint pulling tools then using the Hot Melt adhesive bond and position the 6 blocks (3 each side of the

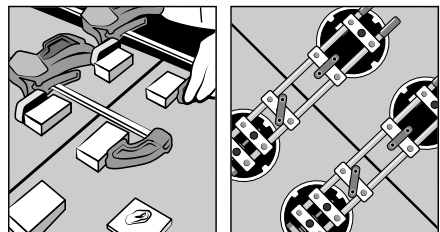

joint) just outside the masked area and lined up so a clamp can be positioned at either side to pull the joint together.

7. Ensure that the appropriate adhesive colour cartridge for the worksurface décor is being used.

It is recommended that disposable gloves are worn when handling the adhesive.

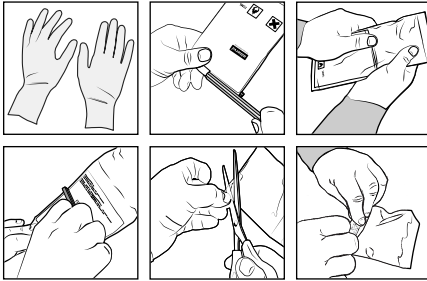

Mix the adhesive as per the instructions with the pack

8. Position the first worksurface onto the base units and apply a coating of the 2-part acrylic adhesive onto the cut edge of the first board.
9. Apply adhesive to the cut edge of the second board.

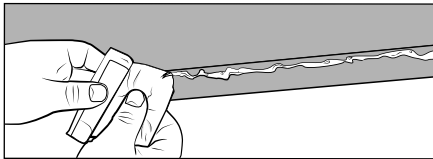

10. Using either the Seaming Tool or clamps on the glued blocks pull worksurfaces together leaving a gap of approximately 5mm and apply a further bead of adhesive along the gap and into the front edge of the joint.
11. Ensure the surfaces are level and tighten together.

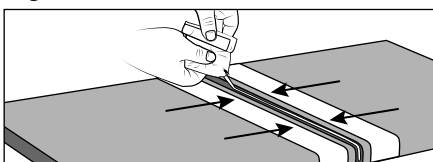

NB. The working time of the adhesive once mixed is around 8-10 minutes depending on ambient temperature.

12. Before the adhesive starts to cure, bridge the strips of masking tape lightly with a spatula or scraper and remove any excess adhesive.

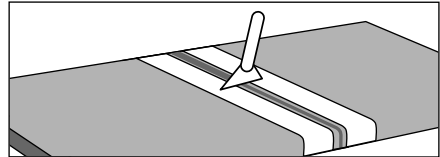

13. Ensure masking tape is removed before adhesive cures leaving a small bead line.

- The hardening time of the adhesive depends on the ambient temperature and the amount of adhesive applied.
- The hardening can be checked with a fingernail or by checking the adhesive in the sachet.
- Tapping the MDF blocks with a sideways motion will normally remove them quite easily. If not, lever them off or carefully use a sharp chisel to break the bond with the surface.

14. Once cured, the bead of adhesive can be removed by sanding with a random orbital sander with the following order of sandpaper grades: P120 to remove the adhesive bead, P240, P320 grit and then finish with grey abrasive pad and a light mist of water. All stages must be carried out with the random orbital sander.



Installation Guide

- Ensure that dust is removed between sanding processes.
- Sand across, up and down then across, up and down in a north - south, east – west style.

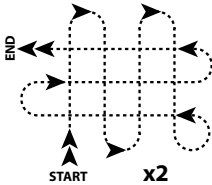

- When changing the sandpaper grade, increase the sanding area slightly to blend in.

Hob, sink and around the wall cutting etc.

1. Making a cut-out in the worksurface for inset hobs, sinks and Belfast sinks it is important to follow the instructions in this section very carefully, especially when making hob cut-outs.

Failure to do so may invalidate the product warranty.

When a matching solid surface splashback is being fitted behind a hob area a minimum of 30mm clearance should be allowed from edge of the hob to the splashback face.

TOP TIP 1

WHEN CUTTING A HOB OR SINK CUT OUT WE WOULD RECOMMEND THAT THE METZO WORKSURFACE IS PLACED ON A SOLID SUBSTRATE WHILST MACHINING.

THIS WILL ENSURE THE CUT OUT DOES NOT DROP AND CAUSE EITHER INJURY OR DAMAGE TO THE SURFACE.

TOP TIP 2

IF MAKING A CUTOUT IT CAN SOMETIMES BE BENEFICIAL TO FABRICATE YOUR OWN JIG FROM MDF

1. Mark the cut out in line with the instructions or template supplied with the sink or hob being used
 2. Mill the cut-out using a router and cutter with minimum 20mm diameter.
- The internal corner radii of the cut-out must be at least 10mm, and the spacing between the hob unit and the worktop must be at least 7mm to allow for air to circulate.

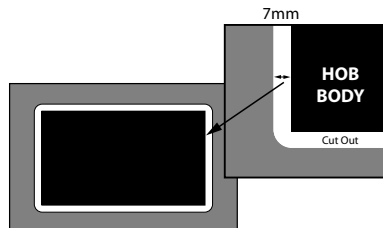

- A radius of at least 3mm must be milled or sanded to the top edge of the solid surface material.
 - A radius must also be used when cutting the worktops to fit around pillars, walls etc.
3. Metal clamping clips should be provided to clamp the sink down onto the worksurface.
 4. Use a silicone sealant to bed the sink onto the worksurface.
 5. **HOBs** Please note that heat resistant tape must be applied around the entire hob cut-out with a slight overlap on the work surface

underneath as illustrated below.

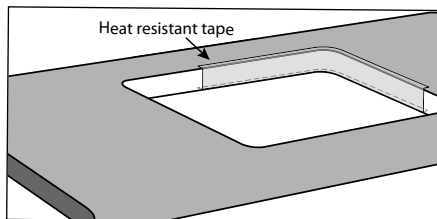

6. The foam strip or gasket provided by the hob supplier must always be fixed under the rim prior to installation of the hob.
7. Please note that dishwashers, washing machines and driers should have a diffuser plate mounted to the underside of the worksurface or heat reflective tape.
8. Make a hole for taps using standard tooling cutting from the top surface.
9. Soften the edge of the cut out with a P320 paper to eliminate any sharp edges.
10. Apply the supplied heat reflective tape to the inside of the cut overlapping by approximately 4mm on the top surface.

Belfast sink cut outs

Belfast sink cut outs should be cut and finished in the same manner.

Take particular care when handling the cut worktop as the resultant cut out leaves a potential weak point to the back edge.

Drainer grooves can be cut to the required length, depth and configuration using a proprietary jig. These jigs usually include the slope to facilitate correct drainage.

Fitting a 'boiling water' tap - Stainless steel sinks only

1. Use a router and 12mm twin flute cutter to machine a hole in accordance with the tap. It may be necessary to use additional brackets to support the end panel or to fix it to the floor or cabinet.

Edge finishing

1. Cut the worksurface to length +5mm using a saw.
2. Trim to exact size using a router to ensure the edge is clean and straight.
3. Using a Random Orbital sander gently soften the top edge and surface with the P240, then using the P320 grit and finally with the grey abrasive pad and a light mist of water to blend.

metzo worktops can easily be cut to form curves or shapes.

We recommend using a jig which should allow you to form clean edges to your required radius.

Always remember the jig needs to allow for the size of your router base.

Cut edges are simply sanded using the 3 grades of sandpaper and the grey finishing pad.

Fitting an alternative sink

- If you are using an alternative sink to the offering in the metzo range, please refer to the manufacturers guide or the section relating to this on our website.

Fitting undermount sink module

When planning for utilising a sink module, care should be taken to ensure that any jointing to be completed is not positioned within 100mm from the sink area and that

Installation Guide

enough additional worksurface is available to complete any required joint into the module.

List of components

- Sink bowls are supplied separate from the module so ensure that the correct number of additional cartons are available. e.g. The 1 & 1/2 bowl module is supplied in 3 boxes - sink module, large bowl and small bowl.
 - Some modules include a pop-up waste kit. Waste fittings and silicone sealant come with all modules.
1. Unpack module ensuring that all required components are present and correct.
 2. Ensure there are no marks or issues with the worksurface and sinks before commencing any work.
 3. It is important not to stand or kneel on the sink module area.
 4. Dry fit/position the module in the area/cabinet it is to be fitted. Make sure you have adequate supply of standard worksurface for extension to the module.
 5. Ensure you position the module with the bowls and drainer positioned according to your requirements.
 6. Before fitting the bowl(s) and fittings into position it is recommended that all joints and edgings be machined as described previously in the booklet.
 7. Once you are confident all the joints and edgings have been machined as required.

Dry fit joints to check

8. Unpack stainless steel bowl(s) and fittings ensuring all components are present and not damaged.
9. Clean the surfaces on the bowl edges to be mounted and the edge of the module where the sink will be bonded, ensuring that all dust, debris and dirt is removed.
10. Apply a generous bead of the supplied silicone to the stainless steel bowl edge area and apply to the worksurface ensuring no gaps are left anywhere in the bead to achieve a watertight fit.
11. Apply each sink carefully making sure to check the waste overflow is positioned correctly and insert screw fixings and sink clips to the underside, carefully applying and ensuring the screw is not over-tightened as this can result in damage to the material.

**DO NOT USE A POWER DRIVER.
USE A HAND TOOL.**

12. Check sink positions are even and correct and adjust if necessary.
13. Position the module in the unit and make necessary joints into the module as required using the aforementioned processes.
14. Wipe away any excess silicone.
15. Allow 24 hours for the silicone to fully cure before using the sink (i.e. filling with water).

Handy Tips

- When tiling down to the worksurface leave a minimum of 3mm gap between the bottom row of tiles and the worksurface. This gap should be sealed with a silicone sealant.

Do not fill the gap with grout.

- When scribing the worktop to the back wall use an electric planer with TCT blades.
- When fitting sink modules it is a good idea to dry fit onto the cabinet in order to mark out the positioning of the bowl to the front & back rails of the carcass. This will enable the easy removal of excess rail to allow for correct sink positioning.

Before installation please thoroughly check your surfaces for damage and colour consistency

Surface finish

Over a short period of time in use in the home, your worktops will develop a smoother finish and more lustrous appearance. In the first days after installation the dry finish of the surface may show finger marks more readily than it will do when it has achieved this 'patina'. Regular cleaning with warm soapy water is the usual first step to remove surface marks.

If grease marks remain, the gentle abrasive of Cif cream cleaner will remove most marks without harming the surface at all. This sort of cleaner has a positive effect on the acrylic surface. For very stubborn grease marks or burnt on areas of fat splashes for instance, Fairy Power Spray will cut through this very easily.

Initial treatment and cleaning

First ensure that your worksurface is thoroughly cleaned with warm soapy water or Fairy Power Spray to remove any greasy residues. A mild abrasive cream cleaner such as Cif cream is also a good part of your regular maintenance regime.

Solid Surface Clean & Care

Solid Surface Clean & Care is designed with Stay Clean technology, creating an invisible shield that helps prevent everyday dirt adhering to the worktops. The powerful quick cleaning formula easily tackles grease & grime ensuring a streak and spot free finish to your worktop. Apply a generous amount to the surface to be cleaned, and wipe off with a clean cloth. For any stubborn dirt, repeat the application and leave for 1 minute before wiping.

WHENEVER TRYING TO REMOVE MARKS OR SCRATCHES ALWAYS TRY THE LEAST SEVERE METHOD FIRST

1. Everyday marks - Using a mild abrasive cleaner such as Cif cream, work in a circular motion; wipe away all residue and buff dry.
2. Fine scuffs and scratches - Cover the affected area with a liberal amount of soapy water. Place the grey abrasive pad* onto the wet surface and, using a sanding block* or firm sponge to ensure even spread of pressure, rub over the affected area in a circular motion. A slight paste will be generated that aids the finishing process and helps to maintain the original level of surface finish. Repeat step 1. If marks are still evident, repeat the grey abrasive pad process or, in the case of deeper scratches, move on to step 3.
3. Removal of deeper scratches - Ensure that the surface is clean and dry before starting. Place the sanding disc* onto the sanding block ensuring that it is located correctly and wrapped onto both sides of the block.

Using small circular movements, work a small area around the affected part of the surface. A small amount of dust will be

Care and Maintenance

generated – this will need to be wiped off to check progress and before moving onto the next step. When the mark has been removed the repaired area will retain very fine sanding marks; these are removed by repeating step 2 and then step 1 to blend in the refurbished area. Each time you move back through the steps, work a slightly wider area so as to help this blend in.

Items marked with '*' are included as part of the Care Kit available from your retailer.

Please Note

Darker colours show scratches and marks more easily and should be treated with extra care and attention during and after installation.

Cleaning your worksurface

THINGS TO DO

To prevent damage from hot objects, always use heat resistant mats or trivets on the surface of the worktop.

Always use a chopping board for preparing food.

Wipe spilt liquids away. Ensure that all inset appliances are properly sealed as per fitting instructions.

Wipe immediately with damp cloth. Dried on residues can be removed with a mild abrasive domestic cleaner. Rub gently, rinse and wipe dry.

Cleaning with a sponge, water and mild detergent liquid is sufficient for normal maintenance.

THINGS TO AVOID

Do not place hot objects directly on the worktop. e.g. pans, steamers.

Do not cut directly on the worktop. Heavy crockery, kitchen utensils and other objects sliding on a worksurface can produce fine scratches.

Avoid contact with aggressive chemical substances such as nail polish remover, chlorine, acetone, drain cleaner etc.

Do not use very abrasive cleaners and solvents as cleaning agents.

Mark and stain removal

FOODS: Tea, coffee, milk, fruit juice, curry, red wine, vinegar, lemon juice and beetroot can all be removed using a damp cloth, warm water and a mild detergent.

GENERAL HOUSEHOLD

<i>Stain/Mark</i>	<i>Damp cloth</i>	<i>Warm water and mild detergent</i>	<i>White spirit</i>
Oil	•	•	
Water based paint		•	
Solvent based paint		•	•
Permanent Dyes			•
Shoe polish			•
Biro		•	
Lipstick		•	

Warranty

WARRANTY

Your worktops have a 10 year warranty against manufacturing defects. The additional 9 year warranty (1 year is statutory) should be registered no later than 90 days from the date of installation to validate any claims. In order to validate this warranty, the form on page 17 must be completed by the consumer, signed by the fitter and returned to Carysil Surfaces.

You can also register your warranty online at bit.ly/metzowarranty.

It is imperative that the installation and care and maintenance instructions are referred to both before and after installation, as misuse of the worksurface may affect the appearance of the product. This does not affect your statutory rights as a consumer.

The warranty applies to the first owner and first installation only and is not transferable.

WARRANTY REGISTRATION FORM: metzo

Name

Address

..... Post Code

Tel

Email

Where did you purchase the work surface?.....

Product reference number

Date of purchase

Product reference number can be found on the metzo packaging and on the underneath of the work surface.

To be completed by installer

I certify that this **metzo** work surface has been fitted in accordance with the prescribed installation instructions.

Signed.....

Date

Please print name (FITTER)

Please return to: Carysil Surfaces Ltd, Azalea Close,
Clover Nook Industrial Park, Alfreton, Derbyshire DE55 4QX
Tel: 01773 521300
E-mail: surfacesales@carysil.co.uk

Or register warranty online at **bit.ly/metzowarranty**

Data Protection: Carysil Surfaces Limited may use your information for administration, customer analysis, customer service and targeted marketing. We may contact you by email, SMS, telephone, fax or other reasonable methods to let you know about other products, services or promotions that may be of interest to you. If you do not want to receive such information and offers then please tick

Notes

CARYSIL
SURFACES

metzo

